

A control system for low-head diversion run-of-river small hydro plants with pressure conduits considering the tailwater level variation

J.I. Pérez-Díaz¹, J. I. Sarasúa¹, J. Fraile-Ardanuy¹, J.R. Wilhelmi¹ and J. A. Sánchez¹

¹ Department of Hydraulic and Energy Engineering
E.T.S. Ingenieros de Caminos, Canales y Puertos, Technical University of Madrid (UPM)
c/ Profesor Aranguren s/n, 28040 Madrid (Spain)
Phone/Fax number: +0034 91 3366705, e-mail: jiperez@caminos.upm.es

Abstract. This paper presents a control system for low-head diversion run-of-river small hydro plants with pressure conduits. Since these hydropower plants usually have low or null water storage capacity, the water discharged through the turbines should be adapted to the possible extent to the natural river inflow. For this purpose, a control scheme aimed at maintaining a constant water level in the head pond is normally used in these cases. As an alternative, the option of maintaining a constant water level in the surge tank is studied in this paper. Furthermore, since in low-head hydro plants the tailwater level variation may represent a relatively important contribution to total head losses, it has been explicitly considered in the proposed control system. A small-perturbation stability analysis has been carried out in order to analyze the influence of the plant design and controller parameters in the plant dynamic response. Finally, in order to illustrate the applicability of the proposed control system, several simulations have been carried out using data gathered from a real hydro plant.

Key words

Low-head hydro; run-of-river hydro; water level control system.

1. Introduction

Run-of-river hydropower plants are increasingly gaining interest in industrialized countries, mainly due to their lower environmental impact in comparison with hydro plants associated to reservoirs with large water storage capacity [1]. The latter are usually operated to supply variable power during periods of peak demand, thus providing the electric grid with operational flexibility and avoiding to the possible extent power level variations in less flexible electric power plants. This operation scheme, referred to in the technical literature as *hydropeaking*, *hydroshifting* or *load-following*, can lead to fluctuating hydrologic patterns in the downstream river reach that can cause in some cases considerable ecological damage to downstream riparian and aquatic

ecosystems. This issue is nowadays receiving special attention, to the extent that in several industrialized countries the corresponding regulatory authorities are reviewing or re-licensing hydropower projects and forcing them to change from peaking operation to run-of-river operation [2].

Run-of-river hydropower plants can be divided into two different types or categories, according to their situation with respect to the river from which the water is taken and conveyed to the turbines: diversion and weir (low dam) schemes. The former, in turn, can be divided into different types according to the way water is conveyed to the turbines. The most widely used scheme for low-head diversion run-of-river plants consists of an open channel, a forebay and a generally short penstock. However, this paper is focused on a less used but more environmentally respectful configuration consisting of a pressure conduit, a surge tank and a short penstock.

Since run-of-river hydro plants usually have low or null water storage capacity, they do not contribute, in general, to load-frequency control of the electrical system. Instead, the water discharged through the turbines is adapted to the possible extent to the natural river inflow, thus considerably reducing the environmental impact on the downstream river reach. For that purpose, a control system aimed at maintaining a constant water level in the head pond is normally used in these cases [3-6]. As an alternative, the option of maintaining a constant water level in the surge tank is studied in this paper. This alternative may improve the performance of the control loop, since the surge tank cross section is usually appreciably smaller than the head pond area. In addition, the distance for water level signal transmission would be strongly reduced.

In low-head plants, the tailwater elevation may represent an important percentage of the plant gross head and may therefore have negative effects on the performance of the

control system and on the plant power generation. For these reasons, its variation as a function of the water flow through the turbines has been explicitly considered in this study.

The main objectives of this study are:

- i. To explore the possibilities of an alternative control system for low-head diversion run-of-river small hydro plants with pressure conduits, aimed at maintaining a constant water level in the surge tank.
- ii. To analyze the influence of the plant design and controller parameters in the plant dynamic response by carrying out a parametric study.
- iii. To develop a simulation model and test the feasibility of the proposed control system.

2. Structure of the control system

The proposed control system is structured in two different control loops. The first one is a closed PI control loop aimed at maintaining a constant water level in the surge tank by continuously adjusting the wicket gate position. The second one is an open control loop aimed at restoring the head that could have varied as a consequence of the action of the first loop. This task is done by readjusting the reference level of the first loop. This action is to be exerted after extinction of the dynamics associated to the first loop response and should be sufficiently slow to allow the first loop to follow the changes smoothly.

With respect to more frequently used schemes, such as those proposed in [3, 7], this control system may introduce some improvements in the dynamic response, since the intermediate elements between the controlled and control variables have been removed from the first control loop. Additionally, the distance to the water level transducer is shorter, thus eliminating the need for long distance signal transmission.

3. Model description

A. First control loop

The block diagram of the first control loop can be seen in Fig. 1. The equations corresponding to each block of the diagram are as follows (the notation used throughout the paper is defined in the Appendix II):

Head pond:

$$A_{hp} \frac{dH_{hp}}{dt} = (Q_{river} - Q_{hr}) \quad (1)$$

Head race conduit:

$$\frac{dQ_{hr}}{dt} = \frac{gF_{hr}}{L_{hr}} (H_{hp} - H_s - K_{hr} Q_{hr} |Q_{hr}|) \quad (2)$$

Surge tank:

$$A_s \frac{dH_s}{dt} = (Q_{hr} - Q) \quad (3)$$

Penstock:

$$\frac{dQ}{dt} = \frac{gF_p}{L_p} (H_s - H - K_p Q |Q| - \Delta H_d) \quad (4)$$

Turbine:

$$Q = Z\sqrt{H} \quad (5)$$

Tailrace area:

$$\Delta H_d = K_d(Q - Q_b) \quad (6)$$

Control module:

$$Z = Z_b \left(z^0 + \frac{K}{H_b} (H_s - H_{ref}) + \frac{1}{H_b T_i} \int (H_s - H_{ref}) dt \right) \quad (7)$$

It is important to note that this is a *rigid water* model, i.e. the water is considered as an incompressible fluid.

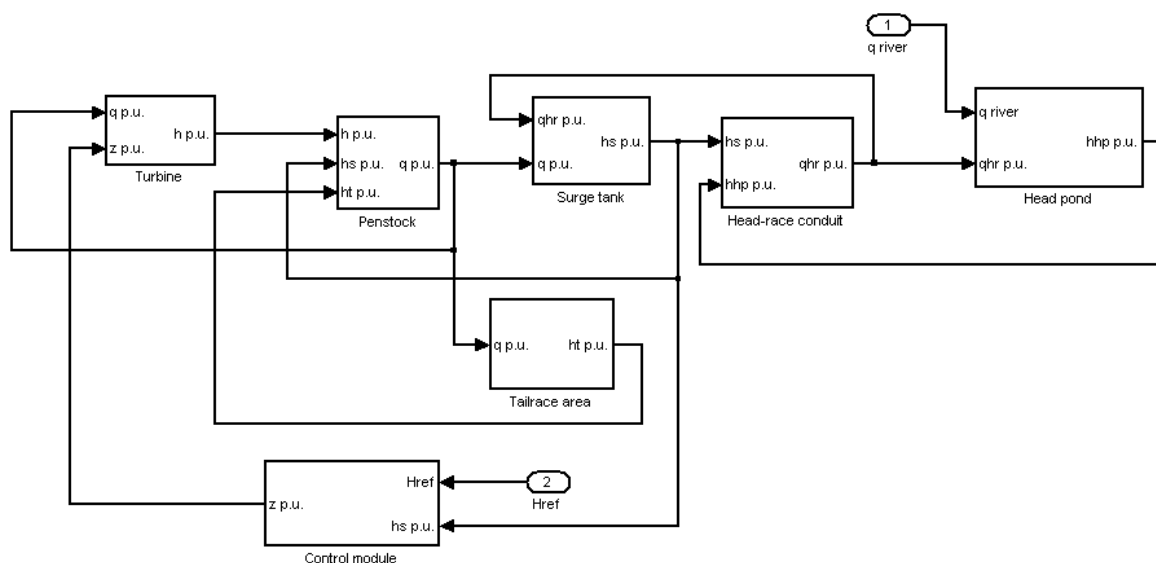

Fig. 1: Block diagram of the first control loop.

B. Second control loop

As a consequence of the action of the first control loop the water level in the head pond may deviate from the reference level specified for plant operation. In order to maintain the water level in the head pond as close as possible to said operational reference level, the second loop periodically updates the surge tank reference level used in the first control loop.

Once the dynamics associated to the first control loop is practically extinguished, the reference level in the surge tank is readjusted by the second control loop, according to the following equation:

$$H_{ref}^* = H_{hp}^{ref} - K_{hr} Q_{hr}^2 \quad (8)$$

Since the plant is operating in a near steady state, the flow in the head race conduit, Q_{hr} , is assumed to be equal to the flow through the turbine, Q , which can be, in turn, deduced from the wicket gates position (the influence of head variation being neglected because the control system is aimed at maintaining the head pond water level). In this way, the use of a flowmeter would not be necessary.

To avoid undesirable effects due to dynamic coupling between the two control loops, the change in reference level is carried out by means of a slow ramp, thus allowing the first loop to follow the change in the smoothest way possible.

4. Stability analysis

In order to evaluate the system stability, previous equations (1)-(7) have been linearized around an initial equilibrium point, as it can be seen in Appendix I. It is important to point out that, since in most cases the penstock dynamics is significantly faster than that of the other components of the hydraulic system, a static model has been used for the penstock-turbine subsystem; hence, the resulting linear model (9)-(12) is of fourth order.

$$\frac{d\mathbf{X}}{dt} = \mathbf{A}\mathbf{X} + \mathbf{B}\mathbf{U} \quad (9)$$

$$\mathbf{X} = \begin{pmatrix} h_{hp} \\ h_s \\ q_{hr} \\ z \end{pmatrix}; \quad \mathbf{U} = \begin{pmatrix} q_{river} \\ h_{ref} \end{pmatrix} \quad (10)$$

$$\mathbf{B} = \begin{pmatrix} \frac{1}{T_{hp}} & 0 \\ 0 & 0 \\ 0 & 0 \\ 0 & -\frac{1}{T_i} \end{pmatrix} \quad (11)$$

$$\mathbf{A} = \begin{pmatrix} 0 & 0 & -\frac{1}{T_{hp}} & 0 \\ 0 & -\frac{b_{11}M}{T_s} & \frac{1}{T_s} & -\frac{b_{13}M}{T_s} \\ \frac{1}{T_{hr}} & -\frac{1}{T_{hr}} & \frac{r_{hr}q_{hr}^0}{T_{hr}} & 0 \\ 0 & \frac{1}{T_i} - K\frac{b_{11}M}{T_s} & K\frac{1}{T_s} & K\frac{b_{13}M}{T_s} \end{pmatrix} \quad (12)$$

where:
$$M = \frac{1}{1 + b_{11}(r_d + r_p q^0)} \quad (13)$$

The characteristic polynomial of the matrix \mathbf{A} may be expressed as:

$$P(\lambda) = |\lambda\mathbf{I} - \mathbf{A}| = \lambda^4 + a_1\lambda^3 + a_2\lambda^2 + a_3\lambda + a_4 \quad (14)$$

where:
$$a_1 = \frac{b_{13}M}{T_s} + \frac{b_{11}M}{T_s} + \frac{r_{hr}q_{hr}^0}{T_{hr}} \quad (15)$$

$$a_2 = \frac{1}{T_{hr}T_{hp}} + \frac{1}{T_{hr}T_s} + \frac{b_{13}M}{T_sT_i} + \frac{b_{11}Mr_{hr}q_{hr}^0}{T_{hr}T_s} + \frac{Kb_{13}Mr_{hr}q_{hr}^0}{T_{hr}T_s} \quad (16)$$

$$a_3 = \frac{b_{11}M}{T_{hr}T_sT_{hp}} + \frac{Kb_{13}M}{T_{hr}T_sT_{hp}} + \frac{b_{13}Mr_{hr}q_{hr}^0}{T_{hr}T_sT_i} \quad (17)$$

$$a_4 = \frac{b_{13}M}{T_{hr}T_sT_{hp}T_i} \quad (18)$$

According to Routh-Hurwitz criterion, the system (9) is asymptotically stable if the following two conditions are satisfied:

- a) All coefficients of the characteristic polynomial of the matrix \mathbf{A} must be different from zero and of the same sign.
- b) All elements in the first column of the Routh array must be positive.

In practice, the first condition is always fulfilled, whereas the second condition may be shown to reduce to:

$$a_1a_2a_3 - a_3^2 - a_2^2a_4 > 0 \quad (19)$$

In the following analysis the head losses in the conduits as well as the tailwater level variation have not been taken into account; it should be noted that this simplification is conservative and allows obtaining simpler stability conditions. So the previous condition (19) can be expressed as follows:

$$T_i > \frac{(1-K)b_{13}^2(b_{11} + b_{13})}{T_s(\alpha + \beta)} \quad (20)$$

where:

$$\alpha = \frac{1}{T_{hr}T_{hp}}(b_{11}^2 + Kb_{13}^2 + Kb_{11}b_{13} + b_{11}b_{13} - (b_{11}^2 + Kb_{13}^2)^2);$$

$$\beta = \frac{1}{T_{hr}T_s}(b_{11}^2 + Kb_{13}^2 + Kb_{11}b_{13} + b_{11}b_{13}) \quad (21)$$

As stated above, the stability region defined by (20) is somewhat conservative, because the head losses in the conduits as well as the tailwater level variation contribute to the plant stability.

5. Case study

In order to illustrate the applicability of the proposed control system, it has been applied in a hydro power plant, which is in the planning stage. Several plant design parameters have been included in Table I.

Table I. Plant design parameters.

Q_b (m ³ /s)	21.95
H_b (m)	4.11
F_{hp} (m ²)	15,353
L_{hr} (m)	442.1
D_{hr} (m)	4.25
K_{hr} (s ² /m ⁵)	2.8e-4
F_s (m ²)	85
L_p (m)	11.4
D_p (m)	3
K_p (s ² /m ⁵)	7.2e-6
K_d (s/m ²)	0.047
q^0 (pu)	1
h^0 (pu)	1
z^0 (pu)	1

Substituting these parameters in the stability condition (20), the stability region shown in Figure 2 is obtained, where K is represented in the x-axis and T_i in the y-axis.

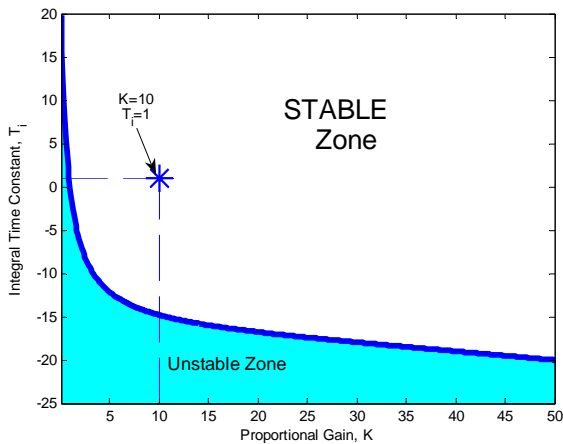

Figure 2: Plant stability region.

It is worth mentioning that this stability region is considerably larger than those obtained in [3] for a more conventional case of head pond water level control, thus compromising the surge tank design to a lesser extent. It is also remarkable that for every $K > 1$, the plant response turns out to be stable, irrespective the value of T_i (provided that it is positive).

The controller parameters, K and T_i , have been adjusted by means of a heuristic criterion proposed in [5, 7], which is based on the root locus method; the resulting parameters being given in Table II.

Table II. Controller parameters.

K	10
T_i	1

Several simulations have been done in order to check the validity of the stability analysis and adjusting criterion, some of which are shown below.

Firstly, the system response to a step reduction in river flow of 5% of the nominal flow at $t = 30$ seconds has been simulated. In Figure 3, it is shown that the water level in the surge tank is kept constant after this perturbation, but the water level in the head pond is reduced.

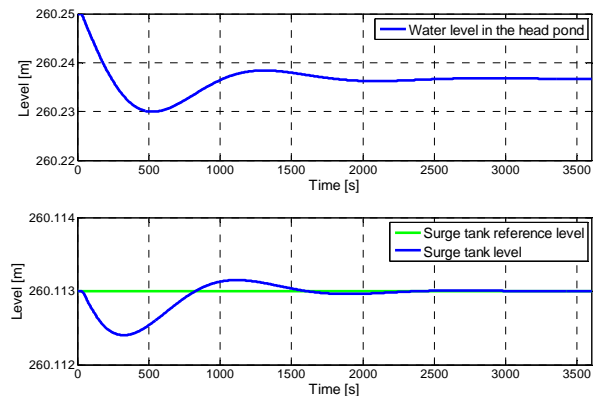

Figure 3: Head pond and surge tank water levels.

Figure 4 shows the evolution of the different flows (river flow, flow in the head race conduit and flow through the turbine). The time evolution of the last both variables are almost indistinguishable.

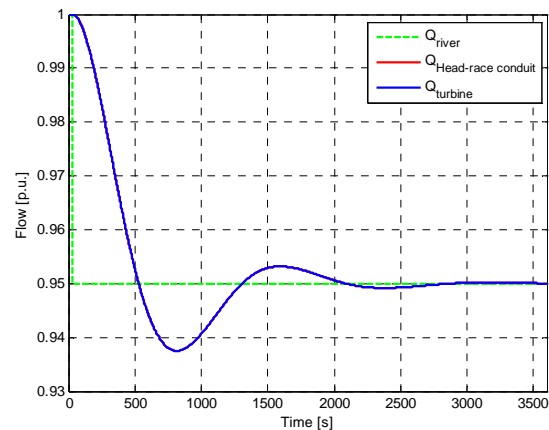

Figure 4: River, head-race conduit and turbine flows.

In order to keep constant the water level in the surge tank, the primary action control should reduce the wicket gates position. This variable is shown in Figure 5.

As a consequence of the action of this first control loop the water level in the head pond has decreased; so, in order to maintain it as close as possible to the operational reference level, after stabilizing the water level of the surge tank, at $t = 3600$ seconds, the surge tank reference level is updated as it is shown in Figure 6.

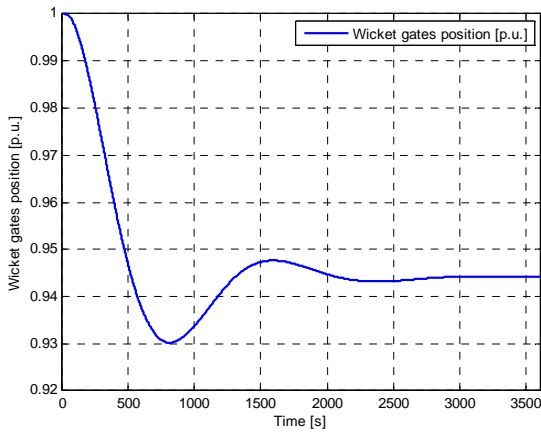

Figure 5: Wicket gates position.

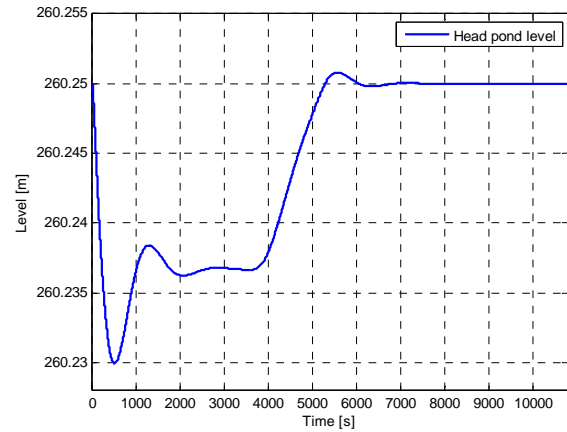

Figure 7: Head pond water level.

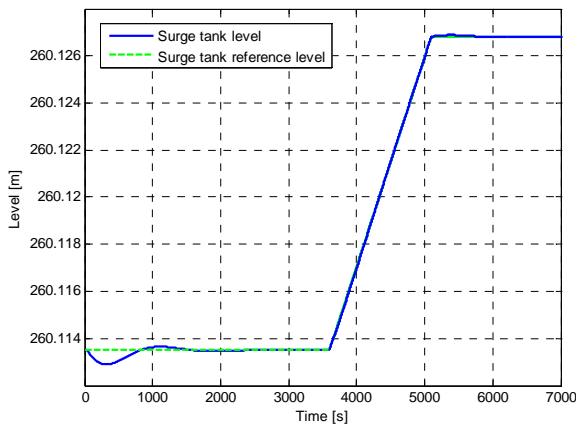

Figure 6: Surge tank water level.

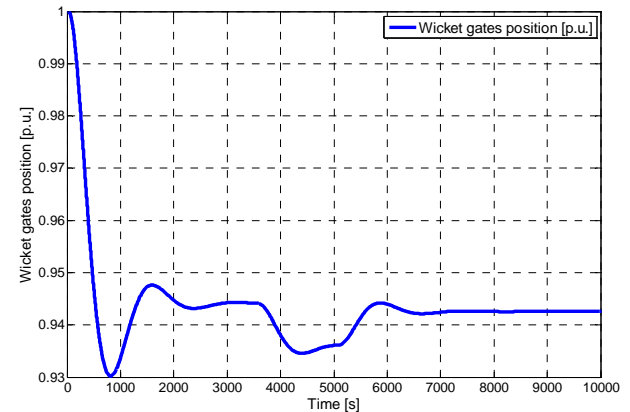

Figure 8: Wicket gates position.

The action of the second control loop is shown in Figure 7. Initially, the water level in the head pond is reduced; then, due to the modification of the surge tank reference level, the head pond level returns to its initial value. Finally, Figure 8 shows the complete wicket gates position time evolution.

6. Conclusions

The main contribution of this study is the analysis of an alternative control system for a low-head diversion run-of-river small hydro plant with pressure conduits.

The proposed control system manages to follow the changes in river flow in a stable way, maintaining a constant water level in the head pond, thus allowing the best possible use of the available water resources.

The results of this study could be used as a support tool to make decisions about certain design parameters of several plant components such as the tailrace, surge tank and head pond areas and about the tuning of the controller parameters.

Appendix I. Model linearization

Per unit values:

$$H = H_b (h^0 + h) \quad (22)$$

$$Q = Q_b (q^0 + q) \quad (23)$$

$$Z = Z_b (z^0 + z) \quad (24)$$

Head pond:

$$\frac{dh_{hp}}{dt} = \frac{1}{T_{hp}} (q_{river} - q_{hr}) \quad (25)$$

Head race conduit:

$$\frac{dq_{hr}}{dt} = \frac{1}{T_{hr}} (h_{hp} - h_s - r_{hr} q_{hr}^0 q_{hr}) \quad (26)$$

where:

$$r_{hr} = 2 \frac{K_{hr} Q_b^2}{H_b} \quad (27)$$

Surge tank:

$$\frac{dh_s}{dt} = \frac{1}{T_s} (q_{hr} - q) \quad (28)$$

Penstock (static model):

$$h = h_c - r_p q^0 q - h_d \quad (29)$$

where:
$$r_p = 2 \frac{K_p Q_b^2}{H_b} \quad (30)$$

Turbine:
$$q = b_{11}h + b_{13}z \quad (31)$$

where:
$$b_{11} = \frac{z^0}{2\sqrt{h^0}}; b_{13} = \sqrt{h^0} \quad (32)$$

Tailrace area:
$$h_d = r_d q \quad (33)$$

where:
$$r_d = \frac{K_d Q_b}{H_b} \quad (34)$$

PI controller:
$$\frac{dz}{dt} = K \frac{dh_s}{dt} + \frac{1}{T_i} (h_s - h_{ref}) \quad (35)$$

Appendix II. Notation

The notation used throughout the paper is presented next (variables are typed in italic):

- A_{hp} Head pond area (m²).
- A_s Surge tank cross sectional area (m²).
- F_{hr} Head race conduit cross sectional area (m²).
- F_p Penstock cross sectional area (m²).
- g Gravity acceleration (m/s²).
- H Net head at the turbine water inlet (metres above sea level, masl).
- h Net head at the turbine water inlet (per unit deviation, pud).
- h^0 Initial net head at the turbine water inlet (per unit value, pu).
- H_b Base, or design, net head (m).
- H_{hp} Water level in the head pond (masl).
- h_d Tailwater level (pud).
- h_{hp} Water level in the head pond (pud).
- h_{hp}^0 Initial water level in the head pond (pu).
- H_s Water level in the surge tank (masl).
- h_s Water level in the surge tank (pud).
- h_s^0 Initial water level in the surge tank (pu).
- H_{ref} Surge tank reference level (masl).
- h_{ref} Surge tank reference level (pud).
- h_{ref}^0 Initial surge tank reference level (pu).
- H_{ref}^* Updated surge tank reference level (masl).
- H_{hp}^{ref} Head pond reference level (masl).
- K Proportional gain of the PI controller.
- K_d Coefficient for tailwater level variation (s/m²).
- K_{hr} Head race conduit losses coefficient (s²/m⁵).

- K_p Penstock losses coefficient (s²/m⁵).
- L_{hr} Head race conduit length (m).
- L_p Penstock length (m).
- Q Flow through the turbine (m³/s).
- q Flow through the turbine (pud).
- q^0 Initial flow through the turbine (pu).
- Q_b Base, or design, flow (m³/s).
- Q_{hr} Flow through the head race conduit (m³/s).
- q_{hr} Flow through the head race conduit (pud).
- Q_{river} River flow (m³/s).
- q_{river}^0 Initial river flow (pu).
- q_{river} River flow (pud).
- T_{hp} Head pond time constant (s).
- T_{hr} Head race conduit time constant (s).
- T_i Integral time constant of the PI controller (s).
- T_p Penstock time constant (s).
- Z Wicket gates opening (rad).
- z Wicket gates opening (pud).
- Z_b Base, or design, wicket gates opening (rad).
- z^0 Initial wicket gates opening (pu).
- ΔH_d Level variation at the tailrace area (masl).

Acknowledgement

The data used in the case study have been provided by L. Maroto to whom the authors are truly grateful.

References

- [1] Paish, O. "Small hydro power: technology and current status", *Renewable and Sustainable Energy Reviews*, vol. 6, no. 6, pp. 537-556, 2002.
- [2] Richter, B.D. and Thomas, G.A., "Restoring environmental flows by modifying dam operations". *Ecology and Society*, vol. 12, no. 1, 2007.
- [3] Jiménez, O.F. and Chaudhry, M.H., "Water-Level Control in HydroPower Plants", *Journal of Energy Engineering*, vol. 118, no. 3, pp. 180-193, 1992.
- [4] Frick, P.A., "Automatic control of small hydroelectric plants", *IEEE Trans. of Power Apparatus and Systems*, vol. PAS-100, no. 5, pp 2476-2485, 1981.
- [5] Sarasúa, J.I., Fraile-Ardanuy, J.J., Pérez-Díaz, J.I., Wilhelmi, J.R. and Sánchez, J.A., "Control of a run of river small hydro power plant", International Conference on Power Engineering, Energy and Electric Drives, Setubal, Portugal, April 12-14, 2007.
- [6] Legros, J.M., Mondon, C. Maurin, S. and Libaux, A. "EDF Hydropower plants operation: new challenges and technical solutions", Waterpower XVI, Spokane, WA, USA, July 27-30, 2009.
- [7] Sarasúa, J.I., *Control de minicentrales fluyentes. Modelado y estabilidad* (PhD dissertation). Technical University of Madrid, 2009. Available at (in Spanish): <http://oa.upm.es/1568/>
- [8] Chaudhry, M.H., *Applied hydraulic transients*. New York: Van Nostrand, 1987.